



## SENSOR SWITCH

Item #	VBS04	Description	VIBRATION SWITCH	Version	V99.0
Page	1 of 7		Date	April 2, 2010	

### ● FUNCTIONS

Omni-directional Vibration Detecting

### ● APPLICATIONS

1. Earthquake detecting system
2. Alarm systems
3. Toys
4. Sporting devices
5. Automotive devices
6. Visual devices
7. Home electrical appliances
8. Information devices
9. Communication devices



### ● FEATURES

1. Housing made of high insulation plastic material, free from electric conduction and rust problem.
2. Detecting with photo transistors, generating highly reliable and stable signals.
3. All plastic materials subject to industrial purpose, resist high temperature and meet fireproof function.
4. Simple ON and OFF signals, easy for design.
5. RoHS compliance, an ideal substitute for mercury switch.
6. A more economical vibration detection option than IC design solution.
7. All made in Taiwan and examined before shipment.

### ● PATENTS

1. TAIWAN Patent NO. I 226467
2. U.S.A. Patent NO. US 6,740,867 B2
3. CHINA Patent NO. ZL 02 1 46662.9



## SENSOR SWITCH

Item #	VBS04	Description	VIBRATION SWITCH	Version	V99.0
Page	2 of 7		Date	April 2, 2010	

● DIMENSIONS / OPERATION / P.C.B. LAYOUT (Unit: mm, Tolerance: ±0.25mm)

VBS 04 01 00	Activate When Being Vibrated From Any Position	P.C.B. Layout (DIP)/Top View

● Device Selection Guide

Input Current (mA)	Operating Voltage (V)
10	5

### Application Circuit

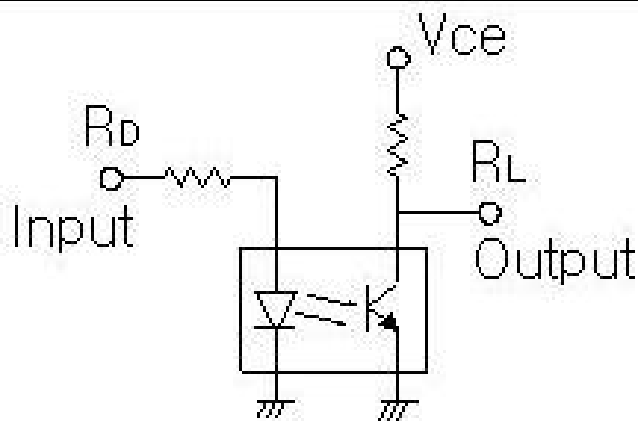

1. Vce=5V
2. RD=430ohn
3. RL=33Kohn



## SENSOR SWITCH

Item #	VBS04	Description	VIBRATION SWITCH	Version	V99.0
Page	3 of 7		Date	April 2, 2010	

### ● Absolute Maximum Rating (Ta=25°C)

	Item	Symbol	Rating	Unit
Input	Power Dissipation	Pd	75	mW
	Reverse Voltage	Vr	5	V
	Forward Current	I <sub>F</sub>	50	mA
	Peak Forward Current (*1)	I <sub>FP</sub>	1	A
Output	Collector Power Dissipation	Pc	100	mW
	Collector Current	Ic	20	mA
	C-E Voltage	V <sub>CEO</sub>	30	V
	E-C Voltage	V <sub>ECO</sub>	5	V
Operating Temperature		Topr	-25~+85	°C
Storage Temperature		Tstg	-40~+100	°C
Soldering Temperature (*2)		Tsol	260	°C

(\*1) tw=100 uSec. 、T=10 mSec.

(\*2) t=5 Sec

### ● MECHANICAL CHARACTERISTICS

1.	Temperature Range	Operating: -25°C to +85°C Storage: -40°C to +85°C
2.	Pull Force of Terminal	500 gf for 1 minute
3.	Operation Life	30,000 hrs.
4.	Humidity	95% RH, 40°C for 96 hrs.
5.	Solder Ability	After flux 260±5°C for 5±0.5 seconds 95% coverage



## SENSOR SWITCH

Item #	VBS04	Description	VIBRATION SWITCH	Version	V99.0
Page	4 of 7		Date	April 2, 2010	

### ● Electrical Optical Characteristics (Ta=25°C)

Parameter	Symbol	Condition	Min.	Typ.	Max.	Unit
Forward Voltage	$V_F$	$I_F=20mA$	—	—	1.5	V
Reverse Current	$I_R$	$V_R=5V$	—	—	10	$\mu A$
Peak Wavelength	$\lambda_p$	$I_F=10mA$		940		nm
Dark Current	$I_D$	$V_{CE}=10V$	—	—	2	$\mu A$
C-E Saturation Voltage	$V_{CE(sat)}$	$I_C=0.25mA$ $I_F=20mA$	—	—	0.4	V
Light Current	$I_L$	$V_{CE}=5V$ $I_F=20mA$	0.5	5	—	mA
Rise Time	$T_r$	$I_C=0.8mA$ $V_{CC}=30V$	—	5	—	$\mu sec$
Fall Time	$T_f$	$R_L=1K\Omega$	—	5	—	$\mu sec$

### ● BILL OF MATERIAL

1.	Housing	Polyamide + Glass-Fiber
2.	Base	Polyamide + Glass-Fiber
3.	Ball	Glass
4.	Infrared Emitting Diodes	
5.	Silicon Photo Transistors	
6.	Inside Part	Copper Alloy, Nickel Plated



## SENSOR SWITCH

Item #	VBS04	Description	VIBRATION SWITCH	Version	V99.0
Page	5 of 7		Date	April 2, 2010	

● Typical Electrical / Optical Characteristics Curves (Ta=25°C)

Fig.1 Power Dissipation vs. Ambient Temperature

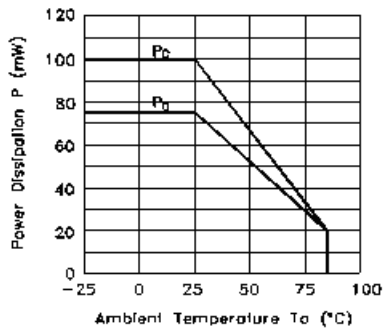

Fig.2 Forward Current vs. Forward Voltage

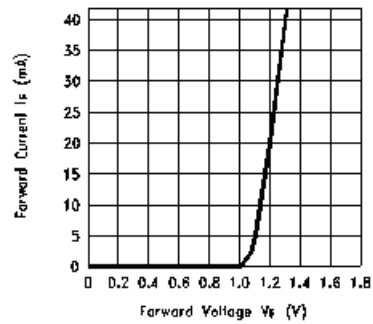

Fig.3 Collector Current vs. Collector-emitter Voltage

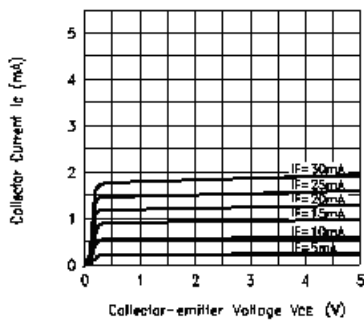
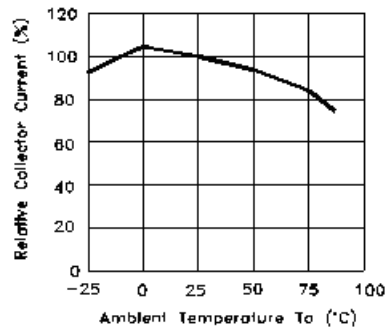

Fig.4 Collector Current vs. Ambient Temperature





## SENSOR SWITCH

Item #	VBS04	Description	VIBRATION SWITCH	Version	V99.0
Page	6 of 7		Date	April 2, 2010	

Fig.5 Collector-emitter Saturation Voltage vs. Ambient Temperature

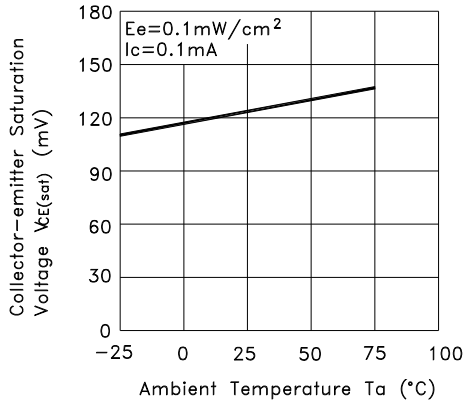

Fig.6 Response Time vs. Load Resistance

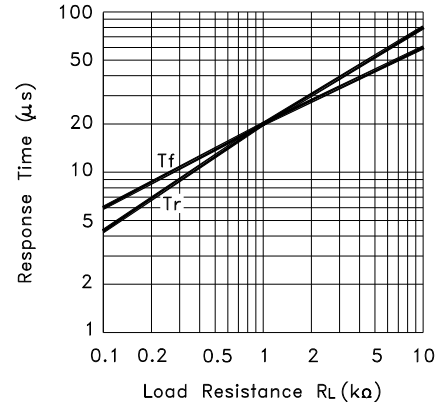
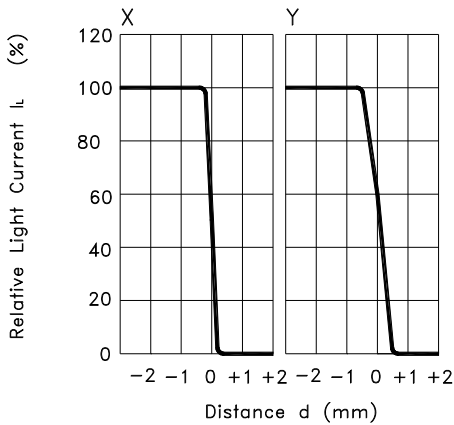
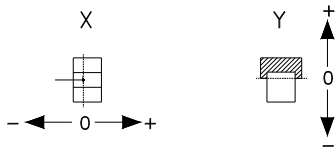

Fig.7 Sensing Position Characteristics (Typical)



(Center of Optical axis)



Test Circuit for Response Time

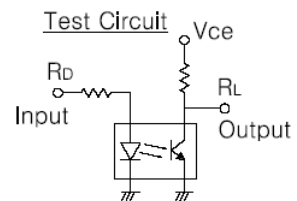
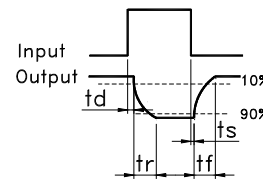
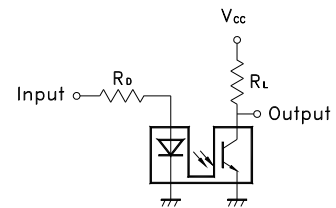



## SENSOR SWITCH

Item #	VBS04	Description	VIBRATION SWITCH	Version	V99.0
Page	7 of 7		Date	April 2, 2010	

### ● PACKAGE

	Part Number	Package	Quantity	Total	Size
1.	VBS040100	PE Bag	250 pcs	250 pcs	12.7 x 17.8 (cm)
		Inner Box	8 Bags	2,000 pcs	36 x 20 x 9 (cm)
		Carton	3 Boxes	6,000 pcs	36 x 28 x 23 (cm)
2.	VBS040100	IC tube	48 pcs	48 pcs	52.5 x 1 x 1.75 (cm)
		Inner Box	84 tubes	4,032 pcs	54 x 13 x 13 (cm)
		Carton	4 Boxes	16,128 pcs	55 x 29 x 29 (cm)

\* Minimum Order Quantity: One Bag / One Box (84 tubes)

### ● NOTE

For the continued product improvement as one of the company policy, specifications may change or update without notice. The latest information can be obtained through our sales offices. Normally, all products are supplied under our standard conditions.

### ● PRECAUTIONS FOR USE

1. If the products is intended to be used for other endurance equipments requiring higher safety and reliability such as life support system, space and aviations devices, disaster and safety system, it's necessary to make verification of conformity or contact us for the details before using.
2. Don't try to clean the switch with a solvent or similar substance after the soldering process.
3. The switch might be damaged if using the water-soluble flux.
4. Don't use the switch in the environment with high humidity or other bedewing possibility, as it may cause leaking among the terminals.